

TOP88[®]

SOLUZIONI INTEGRATE PER UFFICIO

Guida alla scelta delle sedute per spazi di lavoro contemporanei

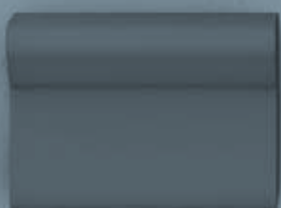

SEIPO[®]

MEISSA



MEISSA



MEISSA

Poltrona direzionale
Managerial chair



M007



M011



M013



M016



M012



M014



M008

DETTAGLI TECNICI TECHNICAL DATA

- Ruote di serie (RT00) a doppia battitura in nylon nero diametro 50 mm.
- Base 5 razze di serie (BS00) in nylon nero (colonna a gas nera) diametro 680 mm.
- Colonna a gas di serie nera di classe 3 con copri pistone nero.
- Movimenti A- B-D
- Scocca anatomicamente curvato in multistrato di legno nella versione alta e bassa.
- Imbottiture in resine poliuretaniche a densità differenziata schiumate a freddo e tagliate da blocco.
- Braccioli di serie (B19) fisso in nylon nero.
- Rivestimenti a scelta fra quelli delle nostre cartelle colori oppure tessuto fornito dal cliente.
- Personalizzazioni possibilità di confezionare il prodotto con colori diversi a parità di categoria, usare filati a contrasto con le finiture, cucire marchio o logo nella poltrona.
- Telaio
- A slitta di serie in acciaio cromato o in acciaio verniciato nero

Le singole schede tecniche per articolo sono disponibili nel ns. sito www.seipo.it

- Standard castors (RT00) twin black nylon 50mm diameter.
- Standard five star base (BS00) in black nylon (black gas lift) 680mm diameter.
- Standard Class 3 black gas lift with black telescopic cover.
- Movements: A- B-D
- Body in anatomically and entirely curved wood for high and low versions.
- Padding in polyurethane resin with diversified density cut from injected block.
- Standard armrests (B19) in fixed black nylon.
- Upholstery choices among our colour charts or supplied by the customer.
- Customization of the product in various colours from the same category, yarns of various colours in contrast to the colour of the chair, sewn logo, brand implementation or other workmanship.
- Frame
- Standard cantilever in chromed or black epoxy powder coated steel.

Each technical data sheet per item code is available on our website www.seipo.it

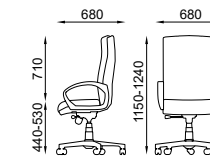

M007 - M008

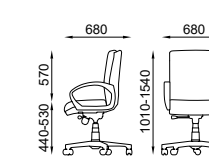

M011 - M012

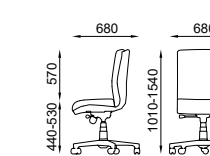

M013

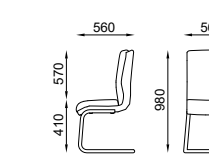

M014 - M015

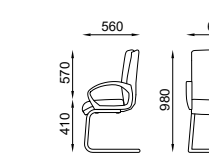

M016 - M017

DETTAGLI / DETAILS



Bracciolo in legno opzionale
Optional wooden armrest



Bracciolo in alluminio con pad in poliuretano nero opzionale
Optional aluminium armrest with black polyurethane pad



Bracciolo in acciaio cromato con pad rivestito in tinta opzionale
Optional chromed steel armrest with upholstered pad



Bracciolo in nylon nero di serie
Standard black nylon armrest



Cuciture sullo schienale
Stitching details on the backrest



Base in acciaio cromato opzionale
Optional chromed steel base



Base in alluminio lucido cromato opzionale
Optional polished aluminium base

BETA



BETA



BETA

Poltrona direzionale
Managerial chair

B081



B084



B083



B085



B089



B087



B082

DETTAGLI TECNICI TECHNICAL DATA

-Ruote di serie (RT00) a doppia battitura in nylon nero diametro 50 mm.
 -Base 5 razze di serie (BS00) in nylon nero (colonna a gas nera) diametro 680 mm.
 -Colonna a gas di serie nera di classe 3 con copri pistone nero.
 -Movimenti A- B- D
 -Scocca anatomicamente curvato in multistrato di legno nella versione alta e bassa.
 -Imbottiture in resine poliuretaniche a densità differenziata schiumate a freddo e tagliate da blocco.
 -Braccioli di serie (B07) fisso in nylon nero.
 -Rivestimenti a scelta fra quelli delle nostre cartelle colori oppure tessuto fornito dal cliente.
 -Personalizzazioni possibilità di confezionare il prodotto con colori diversi a parità di categoria, usare filati a contrasto con le finiture, cucire marchio o logo nella poltrona.
 -Telaio
 -A slitta di serie in acciaio cromato o in acciaio verniciato nero
 Le singole schede tecniche per articolo sono disponibili nel ns. sito www.seipo.it

-Standard castors (RT00) twin black nylon 50mm diameter.
 -Standard five star base (BS00) in black nylon (black gas lift) 680mm diameter.
 -Standard Class 3 black gas lift with black telescopic cover.
 -Movements: A- B- D
 -Body in anatomically and entirely curved wood for high and low versions.
 -Padding in polyurethane resin with diversified density cut from injected block.
 -Standard armrests (B07) in fixed black nylon.
 -Upholstery choices among our colour charts or supplied by the customer.
 -Customization of the product in various colours from the same category, yarns of various colours in contrast to the colour of the chair, sewn logo, brand implementation or other workmanship.
 -Frame
 -Standard cantilever in chromed or black epoxy powder coated steel.
 Each technical data sheet per item code is available on our website www.seipo.it

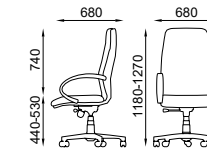

B081 - B082

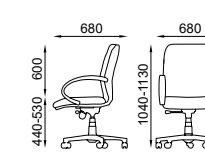

B083 - B084

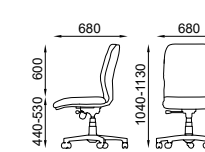

B085

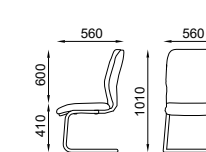

B087 - B088

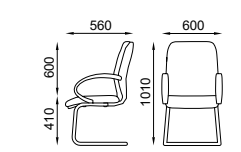

B089 - B090

DETTAGLI / DETAILS

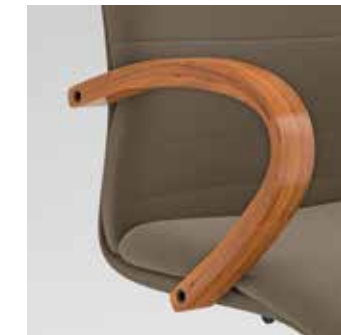
Bracciolo in legno opzionale
Optional wooden armrestBracciolo in alluminio con pad in poliuretano nero opzionale
Optional aluminium armrest with black polyurethane padBracciolo in acciaio cromato con pad rivestito in tinta opzionale
Optional chromed steel armrest with upholstered padBracciolo in nylon nero di serie
Standard black nylon armrestCuciture sullo schienale
Stitching details on the backrestBase in acciaio cromato opzionale
Optional chromed steel baseBase in alluminio lucido cromato opzionale
Optional polished aluminium base

MASK MESH



MASK MESH



MASK MESH

Versione tipo 1
Version type 1

Versione tipo 2
Version type 2



MK02



MK03



MK04



MK07



MK05



MK08



MK06



MK09



MK01



MK11



MK12



MK13



MK14



MK17



MK15



MK18



MK16



MK19



DETTAGLI TECNICI TECHNICAL DATA

- Ruote di serie (RT00) a doppia battitura in nylon nero diametro 50 mm.
- Base 5 razze di serie (BS07) in nylon nero (colonna a gas nera) diametro 640 mm.
- Colonna a gas di serie nera di classe 3 con copri pistone nero.
- Movimenti R2-R4-R6 (Tipo 1) R2-R4-Z (Tipo 2)
- Poggiatesta imbottito e rivestito in tinta con la poltrona.
- Schienale anatomicamente curvato in nylon con rete a scelta fra quelli delle nostre cartelle colori, con sistema up and down e supporto lombare autoregolante in inclinazione.
- Sedile interno in nylon con barre di rinforzo in acciaio con relativo sotto sedile di colore nero con traslatore incorporato. (Tipo1)
- Sedile interno in multistrato di legno anatomicamente sagomato con relativo sotto sedile in nylon. (Tipo2)
- Imbottiture interamente stampate e schiumate a freddo. (Tipo1)
- Imbottiture in resine poliuretaniche a densità differenziata schiumate a freddo e tagliate da blocco. (Tipo2)
- Braccioli di serie (BR25) in nylon nero con pad in poliuretano regolabile in 4D. (Tipo 1)
- Braccioli di serie (B10) fisso in nylon nero. (Tipo 2)
- Rivestimenti a scelta fra quelli delle nostre cartelle colori oppure tessuto fornito dal cliente.
- Personalizzazioni possibilità di confezionare il prodotto con colori diversi a parità di categoria, usare filati a contrasto con le finiture, cucire marchio o logo nella poltrona.

Le singole schede tecniche per articolo sono disponibili nel ns. sito www.seipo.it

- Standard castors (RT00) twin black nylon 50mm diameter.
- Standard five star base (BS07) in black nylon (black gas lift) 640mm diameter.
- Standard Class 3 black gas lift with black telescopic cover.
- Movements: R2-R4-R6 (Type 1) R2-R4-Z (Type 2)
- Padded headrest in the same upholstery colour as the chair.
- Backrest in anatomically curved nylon in available mesh colours from our colour chart, up-down system, self-adjusted lumbar support in inclination.
- Internal seat in black nylon with reinforced steel bars and pertinent black under seat with incorporated seat slider. (Type 1)
- Internal seat in anatomically shaped multilayered wood with pertinent nylon under seat. (Type 2)
- Padding entirely in injected polyurethane. (Type 1)
- Padding in polyurethane resin with diversified density cut from injected block. (Type 2)
- Standard 4D adjustable armrests (B25) in black nylon with polyurethane pad. (Type 1)
- Standard armrests (B10) in fixed black nylon. (Type 2)
- Upholstery choices among our colour charts or supplied by the customer.
- Customization of the product in various colours from the same category, yarns of various colours in contrast to the colour of the chair, sewn logo, brand implementation or other workmanship.

Each technical data sheet per item code is available on our website www.seipo.it

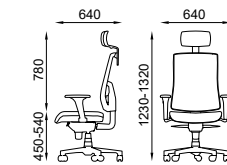

MK01 - MK02 - MK03

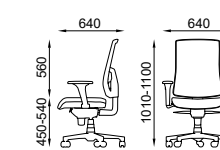

MK04 - MK05 - MK06

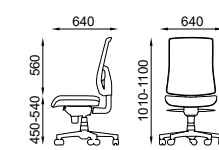

MK07 - MK08 - MK09

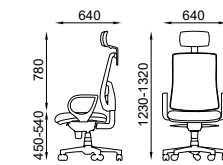

MK11 - MK12 - MK13

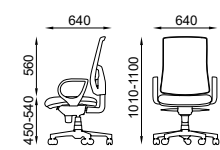

MK14 - MK15 - MK16

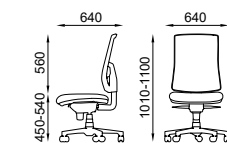

MK17 - MK18 - MK19

DETTAGLI / DETAILS



Retro schienale e supporto lombare
Rear backrest with lumbar support



Cuciture del sedile tipo 1
Stitching details of seat type 1



Bracciolo regolabile 4D di serie
su Tipo 1
Standard 4D adjustable armrest on
type 1



Meccanica sincronizzata R6
R6 synchronized mechanism

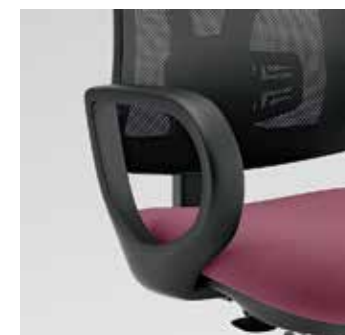

Bracciolo fisso in nylon nero di serie
su Tipo 2
Standard fixed black nylon armrest on
type 2

Q-TRE



Q-TRE

Versione nera tipo 1
Black version type 1



Q022



Q023



Q024



Q027



Q025



Q028



Q026



Q029



Q021

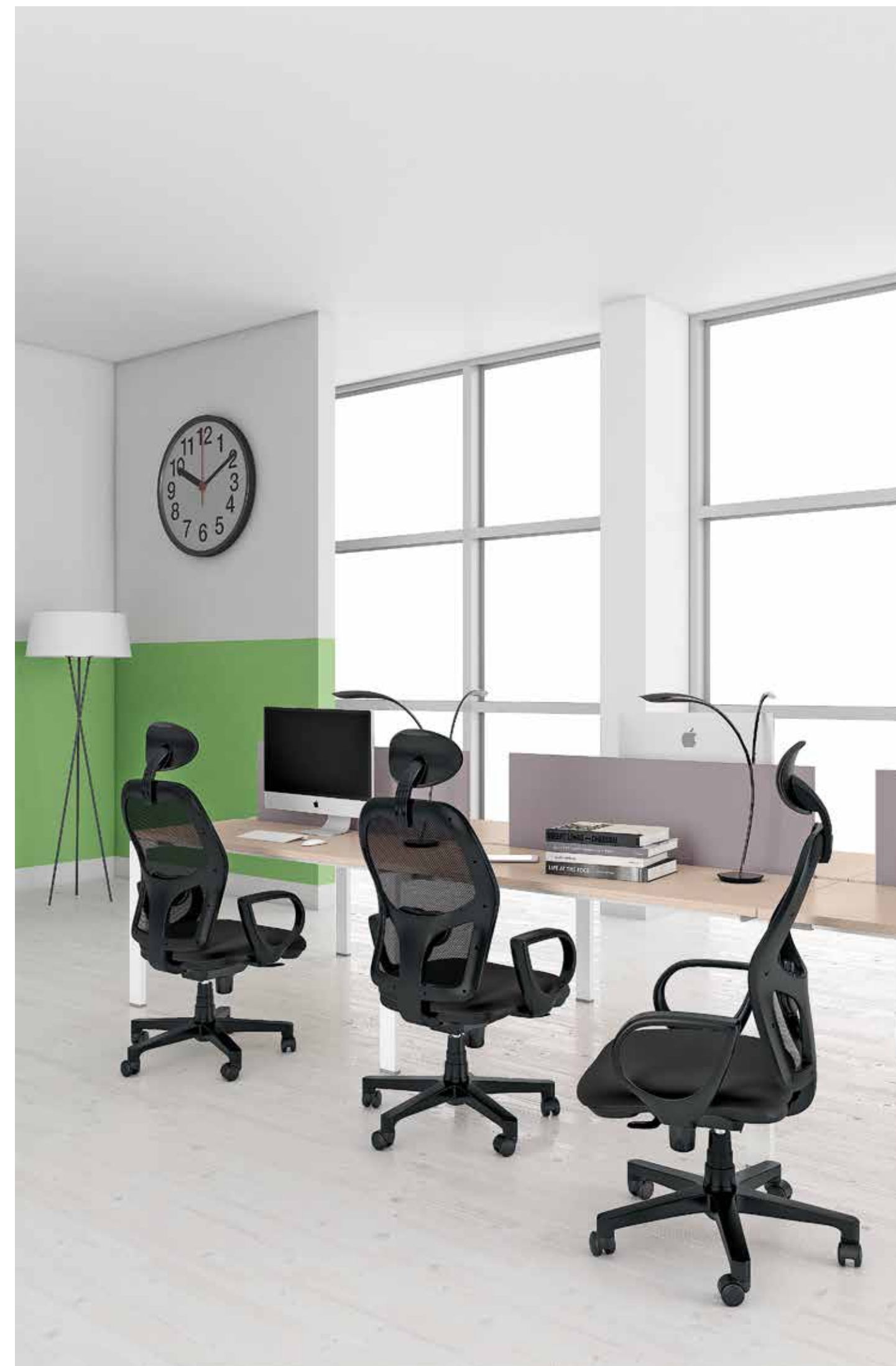



Q-TRE

Versione grigia tipo 1
Grey version type 1



Q030



Q033

Q034

Q031

Q032

Q035

Q-TRE

Versione tipo 2
Version type 2



Q042



Q043



Q044



Q047



Q045



Q048



Q046



Q049



Q041



DETTAGLI TECNICI TECHNICAL DATA

Q-TRE TIPO 1

-Ruote di serie (RT00) a doppia battitura in nylon nero o grigio diametro 50 mm.
 -Base 5 razze di serie (BS07) in nylon nero diametro 640 mm. o (BS49) in nylon grigio diametro 630
 -Colonna a gas di serie nera di classe 3 con copri pistone nero.
 -Movimenti R2-R4-Z
 -Poggiatesta imbottito e rivestito in tinta con la poltrona.
 -Schienale anatomicamente curvato in nylon con rete a scelta fra quelli delle nostre cartelle colori, supporto lombare regolabile in altezza.
 -Sedile interno in multistrato di legno anatomicamente sagomato con relativo sotto sedile in nylon nero o grigio.
 -Imbottiture in resine poliuretatiche a densità differenziata schiumate a freddo e tagliate da blocco.
 -Braccioli di serie (B10) fisso in nylon nero o (B65) fisso in nylon grigio.
 -Rivestimenti a scelta fra quelli delle nostre cartelle colori oppure tessuto fornito dal cliente.
 -Personalizzazioni possibilità di confezionare il prodotto con colori diversi a parità di categoria, usare filati a contrasto con le finiture, cucire marchio o logo nella poltrona.
 Le singole schede tecniche per articolo sono disponibili nel ns. sito www.seipo.it

Q-TRE TYPE 1

-Standard castors (RT00) twin black or grey nylon 50mm diameter.
 -Standard five star base (BS07) in black 640mm diameter. or (BS49) in grey nylon 630mm diameter
 -Movements: R2-R4-Z
 -Padded headrest in the same upholstery colour as the chair.
 -Backrest in anatomically curved nylon in available mesh colours from our colour chart, height adjustable lumbar support.
 -Internal seat in anatomically shaped multilayered wood with pertinent black or grey nylon under seat.
 -Padding in polyurethane resin with diversified density cut from injected block.
 -Standard armrests (B10) in fixed black nylon or (B65) in fixed grey nylon.
 -Upholstery choices among our colour charts or supplied by the customer.
 -Customization of the product in various colours from the same category, yarns of various colours in contrast to the colour of the chair, sewn logo, brand implementation or other workmanship.
 Each technical data sheet per item code is available on our website www.seipo.it

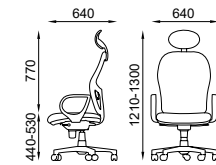

Q021 - Q022 - Q023

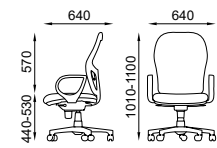

Q024 - Q025 - Q026

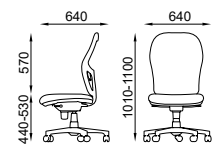

Q027 - Q028 - Q029

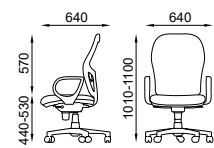

Q030 - Q031 - Q032

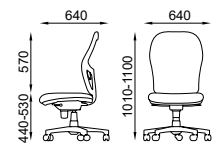

Q033 - Q034 - Q035

DETTAGLI TECNICI TECHNICAL DATA

Q-TRE TIPO 2

-Ruote di serie (RT00) a doppia battitura in nylon nero diametro 50 mm.
 -Base 5 razze di serie (BS07) in nylon nero (colonna a gas nera) diametro 640 mm.
 -Colonna a gas di serie nera di classe 3 con copri pistone nero.
 -Movimenti R2-R4-Z
 -Poggiatesta imbottito e rivestito in tinta con la poltrona.
 -Schienale anatomicamente curvato in nylon con rete a scelta fra quelli delle nostre cartelle colori, supporto lombare regolabile in altezza.
 -Sedile interno in multistrato di legno anatomicamente sagomato con relativo sotto sedile in nylon nero.
 -Imbottiture in resine poliuretatiche a densità differenziata schiumate a freddo e tagliate da blocco.
 -Braccioli di serie (B10) fisso in nylon nero.
 -Rivestimenti a scelta fra quelli delle nostre cartelle colori oppure tessuto fornito dal cliente.
 -Personalizzazioni possibilità di confezionare il prodotto con colori diversi a parità di categoria, usare filati a contrasto con le finiture, cucire marchio o logo nella poltrona.
 Le singole schede tecniche per articolo sono disponibili nel ns. sito www.seipo.it

Q-TRE TYPE 2

-Standard castors (RT00) twin black nylon 50mm diameter.
 -Standard five star base (BS07) in black nylon (black gas lift) 640mm diameter.
 -Movements: R2-R4-Z
 -Padded headrest in the same upholstery colour as the chair.
 -Backrest in anatomically curved nylon in available mesh colours from our colour chart, height adjustable lumbar support.
 -Internal seat in anatomically shaped multilayered wood with pertinent black nylon under seat.
 -Padding in polyurethane resin with diversified density cut from injected block.
 -Standard armrests (B10) in fixed black nylon.
 -Upholstery choices among our colour charts or supplied by the customer.
 -Customization of the product in various colours from the same category, yarns of various colours in contrast to the colour of the chair, sewn logo, brand implementation or other workmanship.
 Each technical data sheet per item code is available on our website www.seipo.it

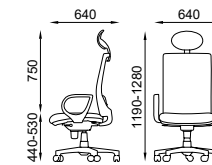

Q041 - Q042 - Q043

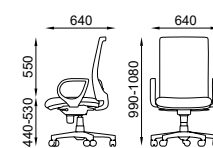

Q044 - Q045 - Q046

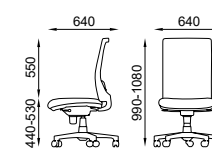

Q047 - Q048 - Q049

DETTAGLI / DETAILS

Retro schienale e supporto lombare Tipo 1
Rear backrest with lumbar support type 1Bracciolo in nylon nero di serie
Standard fixed black nylon armrestBracciolo in nylon grigio di serie
Standard fixed grey nylon armrestBracciolo in nylon regolabile nero
opzionale
Optional black nylon adjustable armrestBracciolo regolabile 3D opzionale
Optional 3D adjustable armrest

DETTAGLI / DETAILS

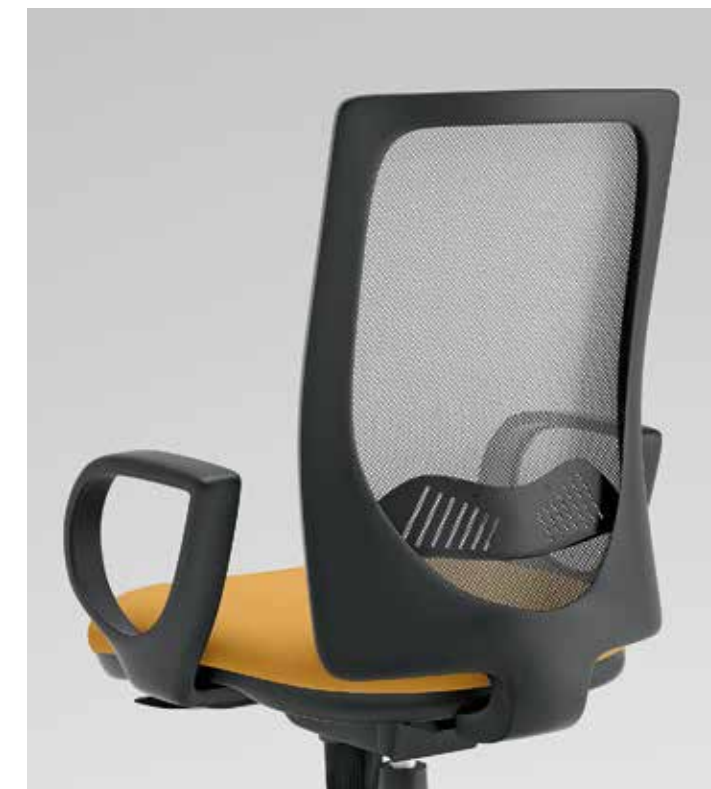
Retro schienale e supporto lombare Tipo 2
Rear backrest with lumbar support type 2Bracciolo regolabile 4D opzionale
Optional 4D adjustable armrestBase in nylon nera di serie
Standard black nylon baseBase in acciaio cromato opzionale
Optional chromed steel baseBase in alluminio lucido opzionale
Optional polished aluminium base

MASK SOFT



MASK SOFT



MASK SOFT

Versione tipo 1
Version type 1

Versione tipo 2
Version type 2



MK22



MK23



MK24



MK27



MK25



MK28



MK26



MK29



MK21



MK31



MK32



MK33



MK34



MK37



MK35



MK38



MK36



MK39



DETTAGLI TECNICI TECHNICAL DATA

- Ruote di serie (RT00) a doppia battitura in nylon nero diametro 50 mm.
- Base 5 razze di serie (BS07) in nylon nero (colonna a gas nera) diametro 640 mm.
- Colonna a gas di serie nera di classe 3 con copri pistone nero.
- Movimenti R2-R4-R6 (Tipo 1) R2-R4-Z (Tipo 2)
- Schienale interno in nylon con barre di rinforzo in acciaio con relativo dietro schienale in nylon, con sistema up and down e supporto lombare regolabile in inclinazione.
- Sedile interno in nylon con barre di rinforzo in acciaio con relativo sottosedile di colore nero con traslatore incorporato. (Tipo 1)
- Sedile interno in multistrato di legno anatomicamente sagomato con relativo sotto sedile in nylon nero. (Tipo 2)
- Imbottiture interamente stampate e schiumate a freddo per il sedile e in resine poliuretatiche a densità differenziata schiumate a freddo e tagliate da blocco per lo schienale (Tipo 1)
- Imbottiture in resine poliuretatiche a densità differenziata schiumate a freddo e tagliate da blocco per sedile e schienale (Tipo 2)
- Braccioli di serie (BR25) in nylon nero con pad in poliuretano regolabile in 4D. (Tipo 1)
- Braccioli di serie (B10) fisso in nylon nero. (Tipo 2)
- Rivestimenti a scelta fra quelli delle nostre cartelle colori oppure tessuto fornito dal cliente.
- Personalizzazioni possibilità di confezionare il prodotto con colori diversi a parità di categoria, usare filati a contrasto con le finiture, cucire marchio o logo nella poltrona. Le singole schede tecniche per articolo sono disponibili nel ns. sito www.seipo.it

- Standard castors (RT00) twin black nylon 50mm diameter.
- Standard five star base (BS07) in black nylon (black gas lift) 640mm diameter.
- Standard Class 3 black gas lift with black telescopic cover.
- Movements: R2-R4-R6 (Type 1) R2-R4-Z (Type 2)
- Padded headrest in the same upholstery colour as the chair.
- Internal backrest in nylon with reinforced steel bars with nylon carter, up-down system, adjustable lumbar support in inclination.
- Internal seat in nylon with reinforced steel bars and pertinent black under seat with incorporated seat slider. (Type 1)
- Internal seat in anatomically shaped multilayered wood with pertinent black nylon under seat. (Type 2)
- Padding in injected polyurethane for the seat, polyurethane resin with diversified density cut from injected block for the backrest. (Type 1)
- Padding in polyurethane resin with diversified density cut from injected block for the seat and backrest. (Type 2)
- Standard 4D adjustable armrests (B25) in black nylon with polyurethane pad. (Type 1)
- Standard armrests (B10) in fixed black nylon. (Type 2)
- Upholstery choices among our colour charts or supplied by the customer.
- Customization of the product in various colours from the same category, yarns of various colours in contrast to the colour of the chair, sewn logo, brand implementation or other workmanship.

Each technical data sheet per item code is available on our website www.seipo.it

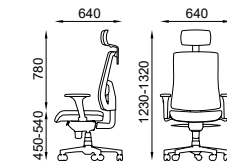

MK21 - MK22 - MK23

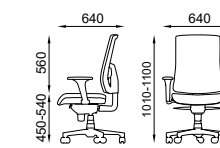

MK24 - MK25 - MK26

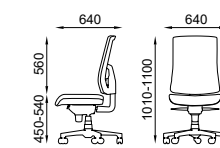

MK27 - MK28 - MK29

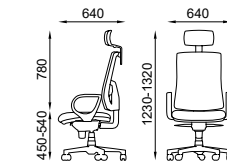

MK31 - MK32 - MK33

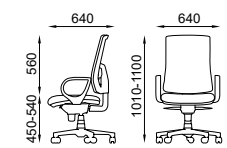

MK34 - MK35 - MK36

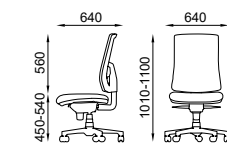

MK37 - MK38 - MK39

DETTAGLI / DETAILS

Retro schienale e supporto lombare
Rear backrest with lumbar supportCuciture del sedile tipo 1
Seat stitching details type 1Bracciolo regolabile 4D di serie
su Tipo 1
Standard 4D adjustable armrest type 1Meccanica sincronizzata R6
R6 synchronized mechanismBracciolo fisso in nylon nero di serie
su tipo 2
Standard fixed black nylon armrest type 2

GLOBE



GLOBE



GLOBE

Versione nera
Black version



G003



G018



G017



G016



G015



G014



G013



G008



G007



G006



G005



G012



G011



G010



G009



G004



G002



G001

Versione grigia
Grey version



G023



G038



G037



G036



G035



G034



G033



G028



G027



G026



G025



G032



G031



G030



G029



G024



G022



G021



DETTAGLI TECNICI TECHNICAL DATA

- Ruote di serie (RT00) a doppia battitura in nylon nero o grigio diametro 50 mm.
- Base 5 razze di serie (BS07) in nylon nero diametro 640 mm. o (BS49) in nylon grigio diametro 630
- Colonna a gas di serie nera di classe 3 con copri pistone nero o grigio.
- Movimenti A2-R2-R4-Z
- Schienale interno in nylon con barre di rinforzo in acciaio con relativo dietro schienale in nylon, con sistema up and down (Mov R2-R4-Z) e supporto lombare regolabile in inclinazione.
- Sedile interno in multistrato di legno anatomicamente sagomato con relativo sotto sedile in nylon nero.
- Imbottiture in resine poliuretaniche a densità differenziata schiumate a freddo e tagliate da blocco per sedile e schienale
- Braccioli di serie (B10) fisso in nylon nero o (B65) fisso in nylon grigio.
- Rivestimenti a scelta fra quelli delle nostre cartelle colori oppure tessuto fornito dal cliente.
- Personalizzazioni possibilità di confezionare il prodotto con colori diversi a parità di categoria, usare filati a contrasto con le finiture, cucire marchio o logo nella poltrona.
- Telai fissi:
 - A slitta di serie in acciaio cromato, verniciato nero o grigio.
 - 4 gambe di serie in acciaio verniciato nero o grigio

Le singole schede tecniche per articolo sono disponibili nel ns. sito www.seipo.it

- Standard castors (RT00) twin black or grey nylon 50mm diameter.
- Standard five star base (BS07) in black 640mm diameter. or (BS49) in grey nylon 630mm diameter
- Standard Class 3 black gas lift with black or grey telescopic cover.
- Movements: A2-R2-R4-Z
- Internal backrest in nylon with reinforced steel bars with nylon carter, up-down system (MOV. R2-R4-Z).
- Internal seat in anatomically shaped multilayered wood with pertinent black or grey nylon under seat.
- Padding in polyurethane resin with diversified density cut from injected block for the seat and backrest.
- Standard armrests (B10) in fixed black nylon or (B65) in fixed grey nylon.
- Optional armrests:
 - Upholstery choices among our colour charts or supplied by the customer.
 - Customization of the product in various colours from the same category, yarns of various colours in contrast to the colour of the chair, sewn logo, brand implementation or other workmanship.
- Fixed frames:
 - Standard cantilever in chromed, black or grey epoxy powder coated steel.
 - Standard black or grey epoxy powder coated steel four legged frame.

Each technical data sheet per item code is available on our website www.seipo.it

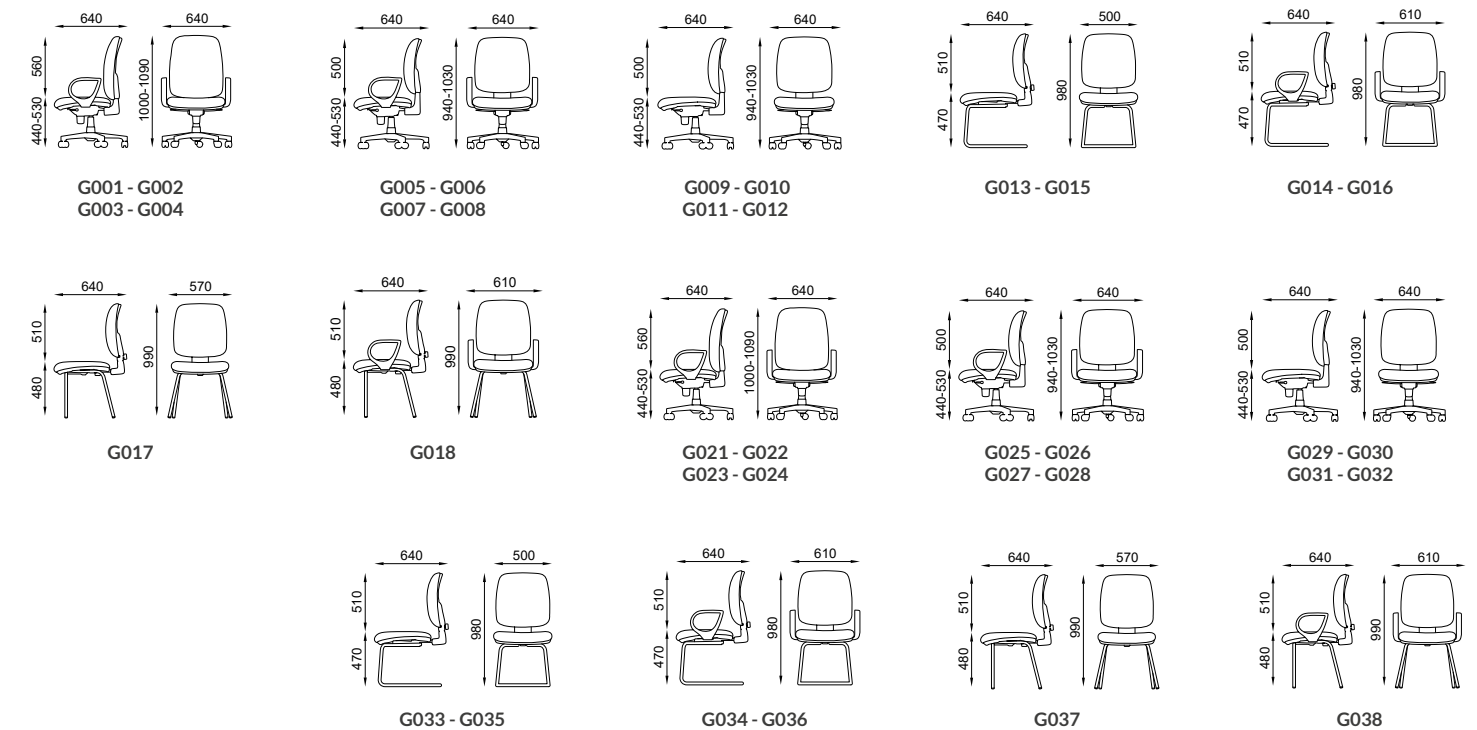

DETTAGLI / DETAILS



Retro schienale
Rear backrest



Bracciolo in nylon regolabile nero
opzionale
Optional adjustable black nylon armrest



Bracciolo regolabile 3D opzionale
Optional 3D adjustable armrest



Bracciolo regolabile 4D opzionale
Optional 4D adjustable armrest

KIT



KIT



KIT 1



KIT 2



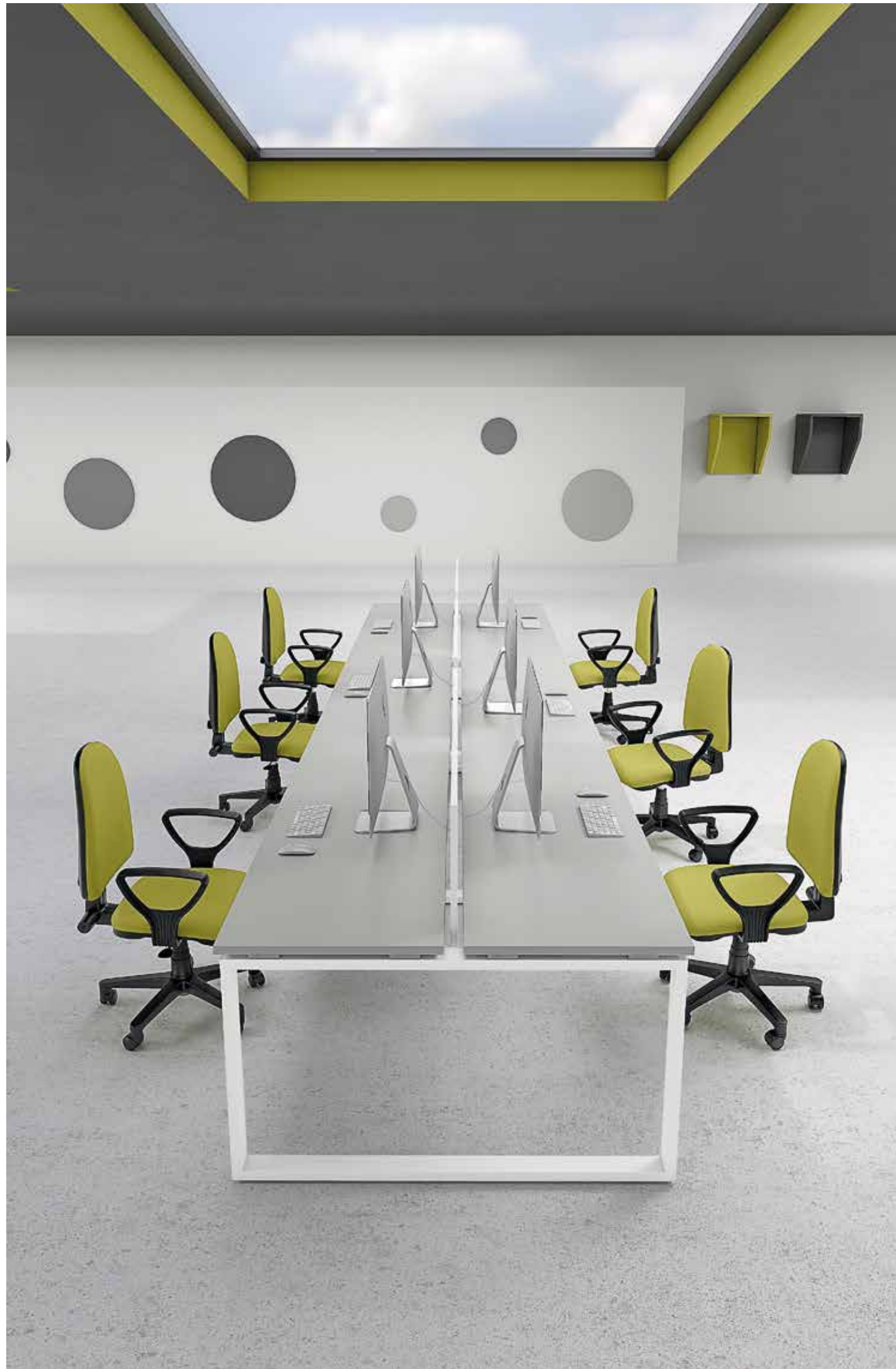

DETTAGLI TECNICI TECHNICAL DATA

- Ruote di serie (RT00) a doppia battitura in nylon nero diametro 50 mm.
- Base 5 razze di serie (BS07) in nylon nero (colonna a gas nera) diametro 640 mm.
- Colonna a gas di serie nera di classe 3 con copri pistone nero.
- Movimenti R2-R4-Z (Tipo 1) A2-P (Tipo 2)
- Schienale interno in nylon con barre di rinforzo in acciaio con relativo dietro schienale in nylon, con sistema up and down e supporto lombare regolabile in inclinazione. (MOV. R2-R4-Z).
- Sedile interno in multistrato di legno anatomicamente sagomato con relativo sotto sedile in nylon nero.
- Imbottiture in resine poliuretaniche a densità differenziata schiumate a freddo e tagliate da blocco per sedile e schienale
- Braccioli di serie (B10) fisso in nylon nero.
- Rivestimenti a scelta fra quelli delle nostre cartelle colori oppure tessuto fornito dal cliente.
- Personalizzazioni possibilità di confezionare il prodotto con colori diversi a parità di categoria, usare filati a contrasto con le finiture, cucire marchio o logo nella poltrona.

Le singole schede tecniche per articolo sono disponibili nel ns. sito www.seipo.it

- Standard castors (RT00) twin black nylon 50mm diameter.
- Standard five star base (BS07) in black nylon (black gas lift) 640mm diameter.
- Standard Class 3 black gas lift with black telescopic cover.
- Movements: R2-R4-Z (Type 1) A2-P (Type 2)
- Internal backrest in nylon with reinforced steel bars with nylon carter, up-down system (MOV. R2-R4-Z).
- Internal seat in anatomically shaped multilayered wood with pertinent black nylon under seat.
- Padding in polyurethane resin with diversified density cut from injected block for the seat and backrest.
- Standard armrests (B10) in fixed black nylon.
- Upholstery choices among our colour charts or supplied by the customer.
- Customization of the product in various colours from the same category, yarns of various colours in contrast to the colour of the chair, sewn logo, brand implementation or other workmanship.

Each technical data sheet per item code is available on our website www.seipo.it

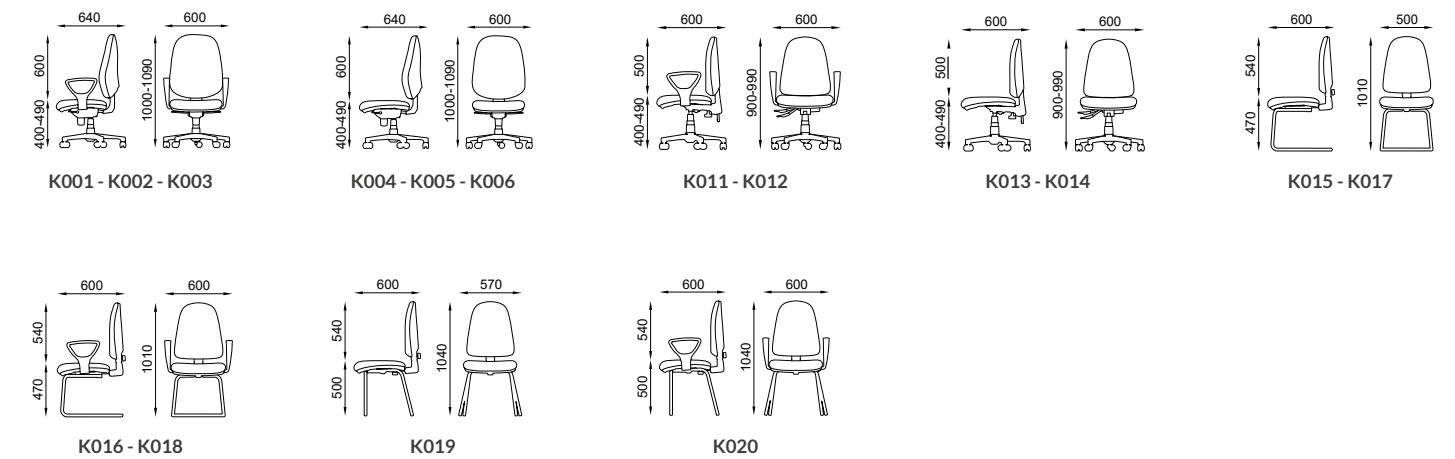

DETTAGLI / DETAILS



Retro schienale Tipo 1
Rear backrest type 1

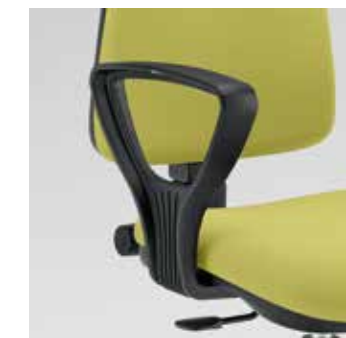

Bracciolo in nylon nero di serie
Standard black nylon armrest



Bracciolo in nylon regolabile nero
opzionale
Optional black nylon adjustable armrest



Bracciolo regolabile 3D opzionale
Optional 3D adjustable armrest



Retro schienale Tipo 2
Rear backrest type 2

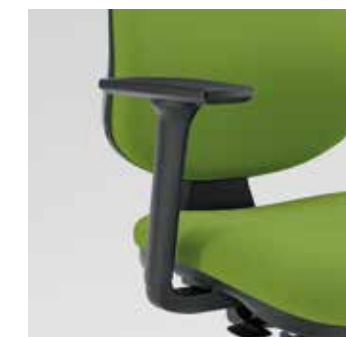

Bracciolo regolabile 4D opzionale
Optional 4D adjustable armrest



Base in acciaio cromato opzionale
Optional chromed steel base



Base in alluminio lucido opzionale
Optional polished aluminium base

SGABELLI



SGABELLI



SGABELLI



S173



S174



S172



S171



S159



S156



S160



S157



S164



S161



S165



S162



S158



S155

DETTAGLI TECNICI TECHNICAL DATA

- Piedini di serie (PD03) in poliammide di colore nero.
- Base 5 razze di serie (BS10) in nylon nero (colonna a gas nera) diametro 600 mm.
- Colonna a gas di serie nera di classe 3 con copri pistone nero nella sedia, senza copripistone negli sgabelli
- Movimenti: A-A2
- Sedile e schienale anatomicamente sagomato, in acciaio stampato con poliuretano nero a pelle integrale. (Versione PU)
- Sedile e schienale anatomicamente sagomato, in multistrato di faggio verniciato naturale. (Versione Faggio)
- Schienale interno in nylon con barre di rinforzo in acciaio con relativo dietro schienale in nylon, con sistema up and down e supporto lombare. (Versione imbottita)
- Sedile interno in multistrato di legno anatomicamente sagomato con relativo sotto sedile in nylon. (Versione imbottita)
- Imbottiture in resine poliuretatiche a densità differenziata schiumate a freddo e tagliate da blocco. (Versione imbottita)
- Braccioli di serie (B18) fisso in nylon nero. (Versione imbottita)
- Anello poggipiedi realizzato in metallo cromato e nylon nero regolabile.

Le singole schede tecniche per articolo sono disponibili nel ns. sito www.seipo.it

- Standard glides (PD03) in black polyamide.
- Standard five star base (BS10) in black nylon (black gas lift) 600mm diameter.
- Standard Class 3 black gas lift
- Movements: A-A2
- Seat and backrest in anatomically shaped steel mould with black integral polyurethane skin. (PU version)
- Seat and backrest in anatomically shaped natural multilayered beech wood. (Wood version)
- Internal backrest in nylon with reinforced steel bars with nylon carter (Soft version)
- Internal seat in anatomically shaped multilayered wood with pertinent nylon under seat. (Soft version)
- Padding in polyurethane resin with diversified density cut from injected block. (Soft version)
- Standard armrests (B18) in fixed black nylon.
- Height adjustable footrest in chromed steel and black nylon.

Each technical data sheet per item code is available on our website www.seipo.it

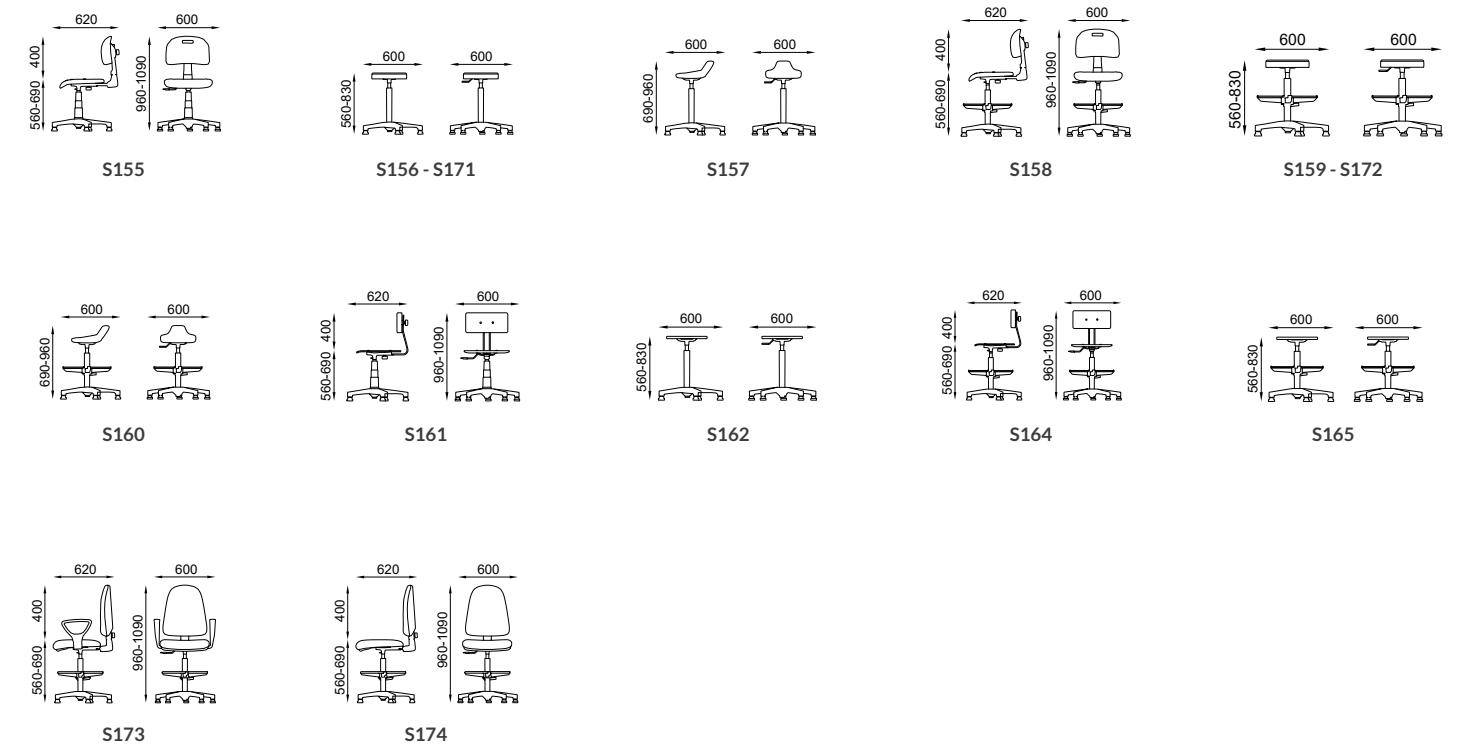

DETTAGLI / DETAILS



Base in nylon nero di serie con piedini
Standard black nylon base on glides



Base in acciaio cromato con piedini
opzionale
Chromed steel base on optional
glides



Base in alluminio lucido con piedini opzionale
Polished aluminium base on optional
glides

WELL SOFA



WELL SOFA

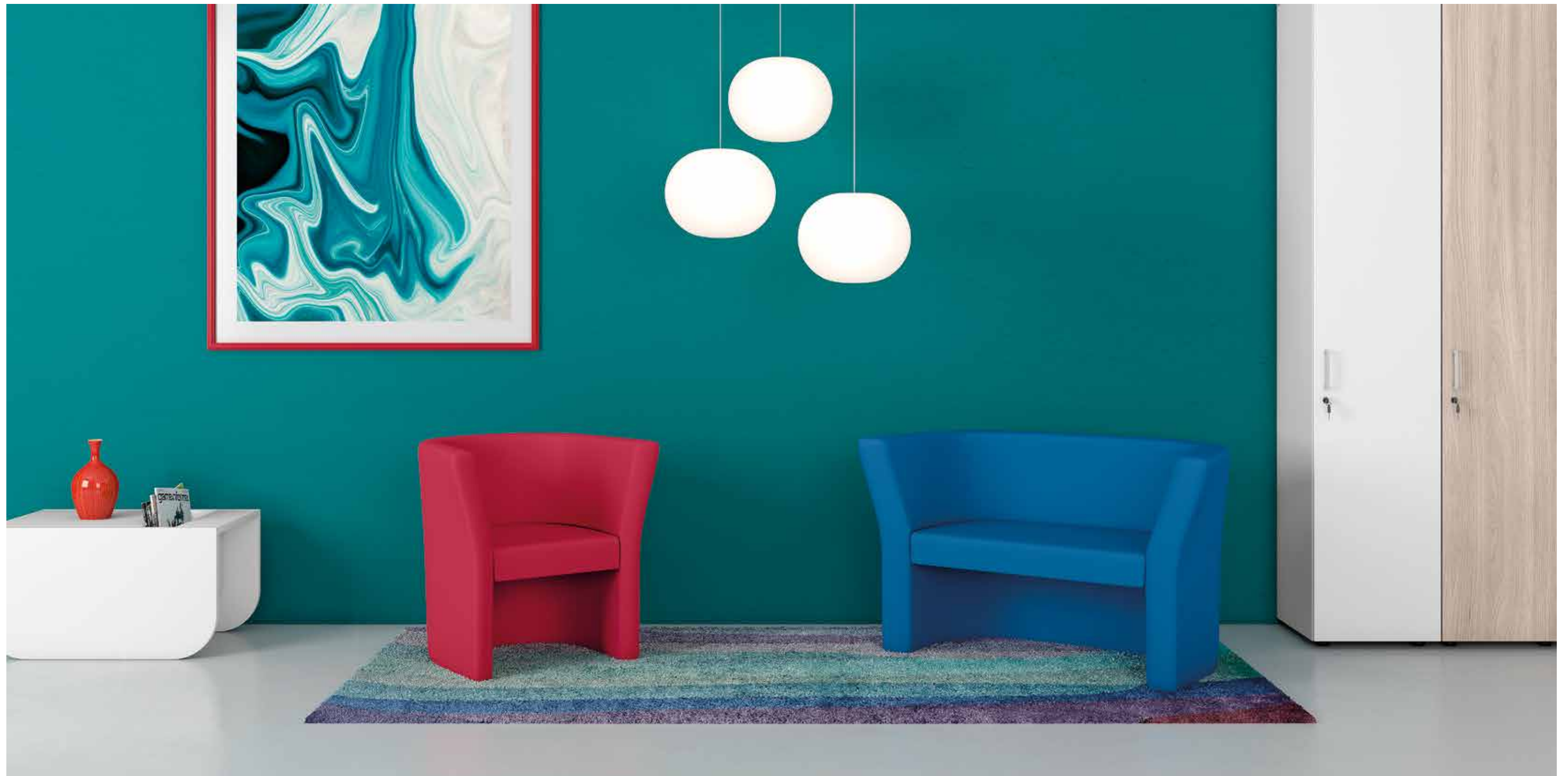

WELL SOFA

Poltrone e divani
Armchairs and sofa



W089



W088

DETTAGLI TECNICI TECHNICAL DATA

- Piedini in nylon nero
- Struttura in multistrato di legno.
- Imbottiture in resine poliuretaniche a densità differenziate schiumate a freddo e tagliate da blocco.
- Imbottiture opzionali in resine poliuretaniche a densità differenziate schiumate a freddo etagliate da blocco, ignifughe conformi alla UNI 9175 Classe 1IM.
- Rivestimenti a scelta fra quelli delle nostre cartelle colori oppure tessuto fornito dal cliente
- Personalizzazioni possibilità di confezionare il prodotto con colori diversi a parità di categoria, usare filati a contrasto con le finiture, cucire marchio o logo nella poltrona.

Le singole schede tecniche per articolo sono disponibili nel ns. sito www.seipo.it

- Feet in black nylon.
- Internal structure in multilayered wood.
- Padding in polyurethane resin with diversified density cut from injected block.
- Optional padding in fire retardant diversified density polyurethane resin cut from injected block conform to UNI 9175 Class 1IM.
- Upholstery choices among our colour charts or supplied by the customer.
- Customization of the product in various colours from the same category, yarns of various colours in contrast to the colour of the chair, sewn logo, brand implementation or other workmanship.

Each technical data sheet per item code is available on our website [HYPERLINK www.seipo.it](http://www.seipo.it)

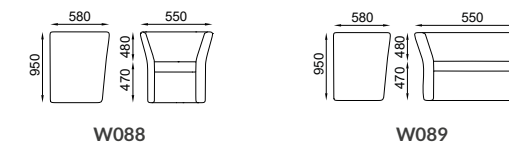

DETTAGLI / DETAILS



Cuciture laterali bracciolo
Lateral armrest stitching details

NEW CLIP



NEW CLIP



NEW CLIP

Poltrone e divani
Armchairs and sofa



DETTAGLI TECNICI TECHNICAL DATA

- Piedini in nylon cromati
- Struttura interna in multistrato di legno.
- Braccioli interni in multistrato di legno.
- Imbottiture in resine poliuretatiche a densità differenziate schiumate a freddo e tagliate da blocco.
- Imbottiture opzionali in resine poliuretatiche a densità differenziate schiumate a freddo e tagliate da blocco, ignifughe conformi alla UNI 9175 Classe 1IM.
- Rivestimenti a scelta fra quelli delle nostre cartelle colori oppure tessuto fornito dal cliente
- Personalizzazioni possibili di confezionare il prodotto con colori diversi a parità di categoria, usare filati a contrasto con le finiture, cucire marchio o logo nella poltrona.

Le singole schede tecniche per articolo sono disponibili nel ns. sito www.seipo.it

- Feet in chromed nylon.
- Internal structure in multilayered wood.
- Internal armrests in multilayered wood.
- Padding in polyurethane resin with diversified density cut from injected block.
- Optional padding in fire retardant diversified density polyurethane resin cut from injected block conform to UNI 9175 Class 1IM.
- Upholstery choices among our colour charts or supplied by the customer.
- Customization of the product in various colours from the same category, yarns of various colours in contrast to the colour of the chair, sewn logo, brand implementation or other workmanship.

Each technical data sheet per item code is available on our website [HYPERLINK www.seipo.it](http://www.seipo.it)

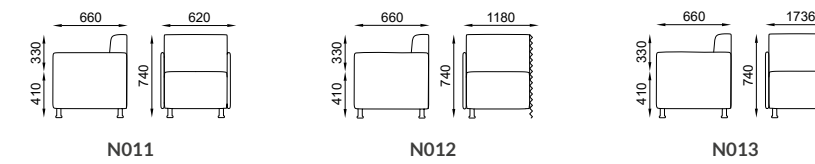

DETTAGLI / DETAILS



N011



N012



N013



Cuciture laterali bracciolo
Lateral armrest stitching details



Piedini cromati
Chromed feet



Retro poltrona in bicolore
Two-tone rear armchair and armrest

STELLA



STELLA

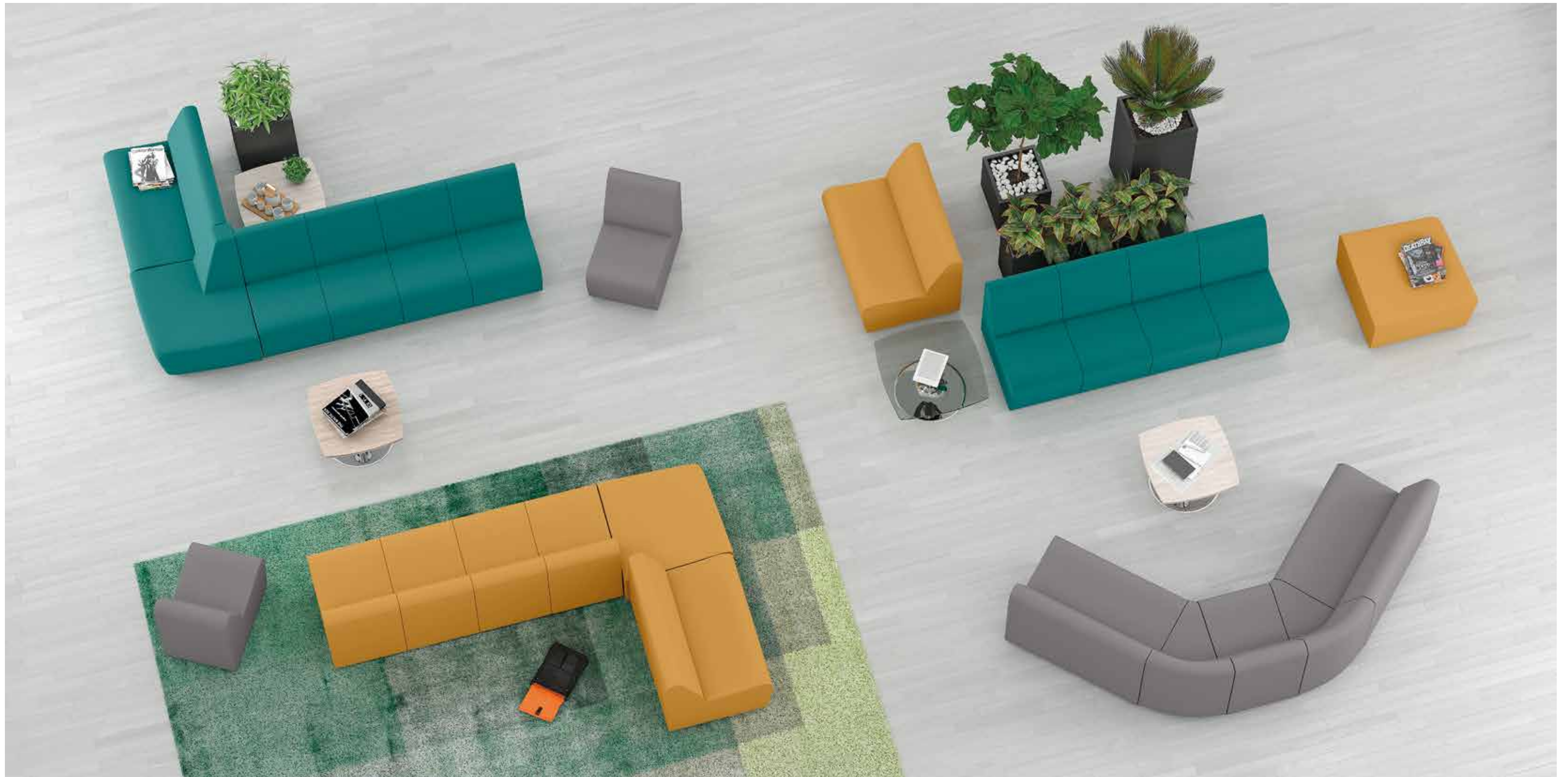

STELLA

Poltrone e divani componibili
Modular armchairs and sofas



ST01



ST02



ST03



ST04



ST05



ST06

DETTAGLI TECNICI TECHNICAL DATA

- Piedini a scomparsa regolabili in nylon nero.
- Struttura interna in acciaio sagomato.
- Imbottiture interamente schiumate a freddo.
- Imbottiture opzionali interamente schiumate a freddo, ignifughe conformi alla UNI 9175 Classe 1IM.
- Rivestimenti a scelta fra quelli delle nostre cartelle colori oppure tessuto fornito dal cliente.
- Personalizzazioni possibilità di confezionare il prodotto con colori diversi a parità di categoria, usare filati a contrasto con le finiture, cucire marchio o logo nella poltrona.

Le singole schede tecniche per articolo sono disponibili nel ns. sito www.seipo.it

- Hidden adjustable feet in black nylon.
- Internal structure in shaped steel.
- Padding entirely in injected polyurethane.
- Optional padding entirely in injected polyurethane conform to UNI 9175 Class 1IM.
- Upholstery choices among our colour charts or supplied by the customer.
- Customization of the product in various colours from the same category, yarns of various colours in contrast to the colour of the chair, sewn logo, brand implementation or other workmanship.

Each technical data sheet per item code is available on our website [HYPERLINK www.seipo.it](http://www.seipo.it)

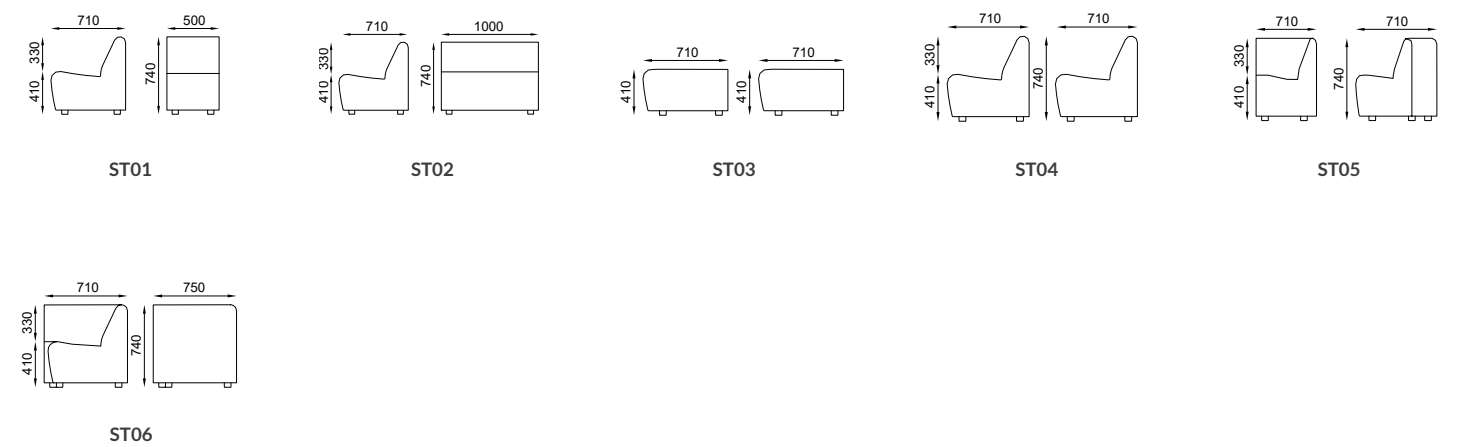

DETTAGLI / DETAILS



Cuciture sedile-schienale
Seat and backrest stitching details



Laterale e sedile bicolore
Two-tone seat and side

WELL



WELL



WELL

Schienale alto
High backrest

Schienale basso
Low backrest



W002C

W012C

W001C

W011C



W002N
carter nero
black carter

W004C
carter nero
black carter



W012N
schienale rivestito
upholstered rear
backrest

W014C
schienale rivestito
upholstered rear
backrest



W001N
carter nero
black carter

W003C
carter nero
black carter



W011N
schienale rivestito
upholstered rear
backrest

W013C
schienale rivestito
upholstered rear
backrest

WELL

Schienale rete
Mesh backrest



W006C



W005C



W005N

DETTAGLI TECNICI TECHNICAL DATA

-Telaio:

---A slitta di serie in acciaio cromato o in acciaio verniciato nero.

---4 gambe di serie in acciaio cromato.

-Schienale imbottito interno in nylon con barre di rinforzo in acciaio con relativo dietro schienale.

-Schienale in rete anatomicamente curvato in nylon con rete a scelta fra quelli delle nostre cartelle colori.

-Sedile interno in nylon anatomicamente sagomato con relativo sotto sedile.

-Imbottiture in resine poliuretatiche a densità differenziata schiumate a freddo e tagliate da blocco.

-Imbottiture opzionali in resine poliuretatiche a densità differenziata schiumate a freddo e tagliate da blocco, ignifughe conformi alla UNI 9175 Classe 1IM.

-Braccioli monoblocco con la struttura con pad in nylon nero.

-Rivestimenti a scelta fra quelli delle nostre cartelle colori oppure tessuto fornito dal cliente.

-Personalizzazioni possibilità di confezionare il prodotto con colori diversi a parità di categoria, usare filati a contrasto con le finiture, cucire marchio o logo nella poltrona.

Le singole schede tecniche per articolo sono disponibili nel ns. sito www.seipo.it

-Frames:

---Standard cantilever in chromed or black epoxy powder coated steel.

---Standard four legged chromed steel frame.

-Padded backrest with internal in nylon and reinforced steel bars with carter.

-Backrest in anatomically curved nylon in available mesh colours from our colour chart.

-Internal seat in anatomically curved nylon with petinent under seat.

-Incorporated monobloc structural steel armrests with black nylon pad.

-Padding in polyurethane resin with diversified density cut from injected block.

-Optional padding in fire retardant diversified density polyurethane resin cut from injected block conform to UNI 9175 Class 1IM.

-Upholstery choices among our colour charts or supplied by the customer.

-Customization of the product in various colours from the same category, yarns of various colours in contrast to the colour of the chair, sewn logo, brand implementation or other workmanship.

Each technical data sheet per item code is available on our website HYPERLINK www.seipo.it

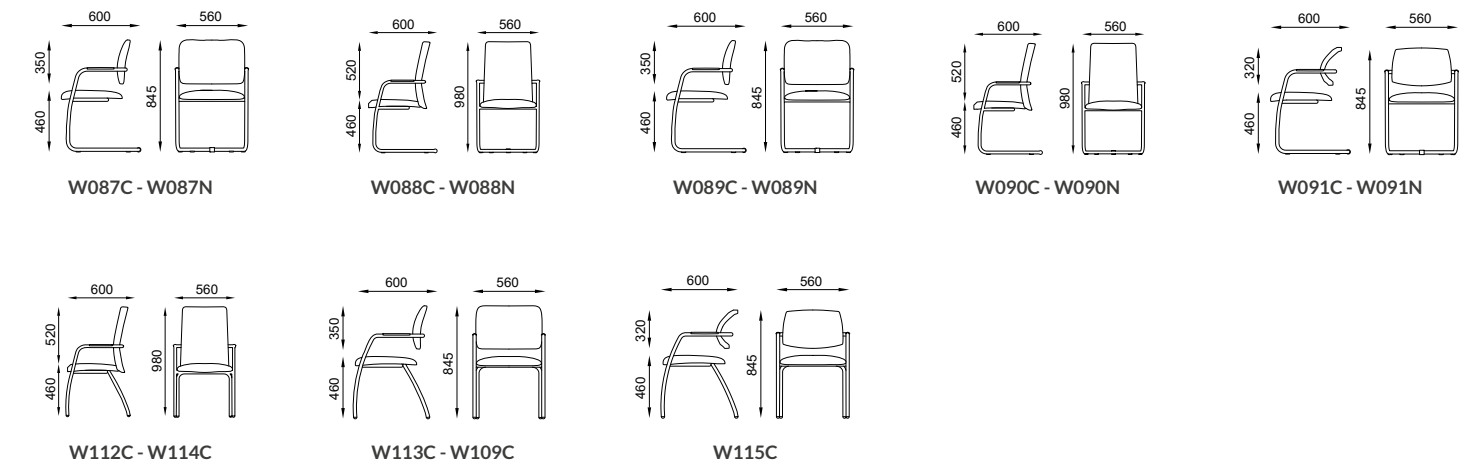

DETTAGLI / DETAILS



Retro con carter basso struttura nera
Low backrest carter with black frame



Retro con carter alto struttura nera
High backrest carter with black frame



Retro rivestito basso struttura nera
Low upholstered backrest with black frame



Retro rivestito alto struttura nera
High upholstered backrest with black frame



Retro schienale in rete struttura cromata
Mesh backrest with chromed frame



Retro schienale in rete struttura nera
Mesh backrest with black frame

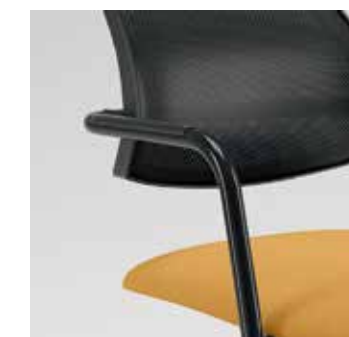

Pad braccioli su struttura nera
Black frame with black nylon armrest pad

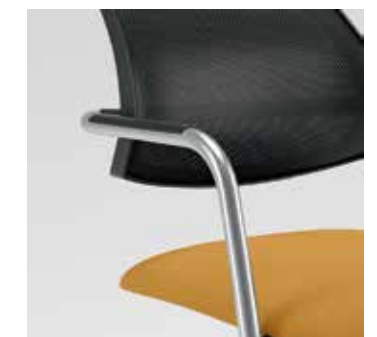

Pad braccioli su struttura cromata
Chromed frame with black nylon armrest pad

PLATE



PLATE

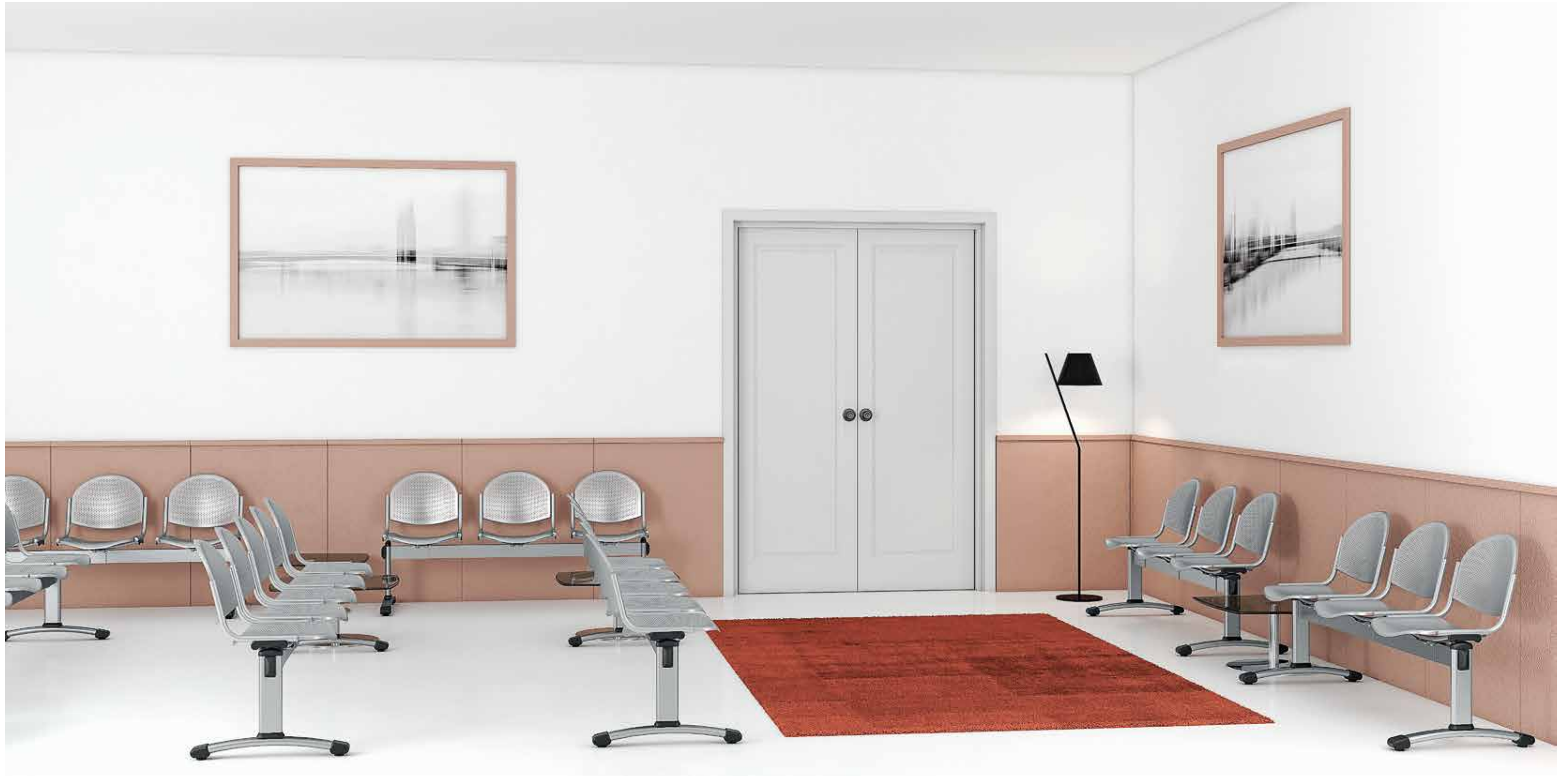

PLATE

Sedie fisse
Fixed chairs



P021G

Panche
Benches



P031G



P025G



P030G



P034G



P031G



P035G



P032G



P036G



P033G



P037G

PLATE

Panche monoscocca
Benches



P051G



P050G



P051G



P052G



P053G

DETTAGLI TECNICI TECHNICAL DATA

Seduta

- Telaio 4 gambe di serie in acciaio verniciato grigio lucido. (Tipo 1)
 - Schienale e sedile in lamiera traforata e verniciata con polveri epossidiche colore grigio lucido (Tipo 1)
 - Braccioli in nylon nero. (Tipo 1)
- Panca su trave
- Gambe di serie in tubo di acciaio verniciato grigio goffrato.
 - Trave in tubo di acciaio sezione mm. 80 per mm. 40 verniciato grigio goffrato.
 - Schienale e sedile in lamiera traforata e verniciata con polveri epossidiche colore grigio lucido(Tipo 1)
 - Schienale e sedile in lamiera traforata e verniciata con polveri epossidiche colore grigio goffrato (Tipo 2)
 - Braccioli in nylon nero. (Tipo 1)

Opzionali

- Gancio di unione per sedie senza braccioli. (Tipo 1)
- Carrello porta sedie verniciato nero. (Tipo 1)
- Piedini per fissaggio a pavimento delle panche mobili.
- Bracciolo terminale per panche in nylon nero. (Tipo 1)

Le singole schede tecniche per articolo sono disponibili nel ns. sito www.seipo.it

Chair:

- Standard four legged frame in grey epoxy powder coated steel. (Type 1)
 - Backrest and seat in open-work grey epoxy powder coated sheet steel. (Type 1)
 - Armrests in black nylon. (Type 1)
- Bench on beam:
- Standard legs in grey epoxy powder coated tubular steel.
 - Beam in grey epoxy powder coated steel section 80mm x 40mm.
 - Backrest and seat in open-work grey epoxy powder coated sheet steel. (Type 1)
 - Backrest and seat in open-work grey epoxy powder coated sheet steel. (Type 2)
 - Armrests in black nylon. (Type 1)

Optionals:

- Union hook for chairs without armrests. (Type 1)
- Chair trolley in black epoxy powder coated steel. (Type 1)
- Feet for mobil bench fastening to pavement.
- Terminal black nylon armrest for benches. (Type 1)

Each technical data sheet per item code is available on our website www.seipo.it

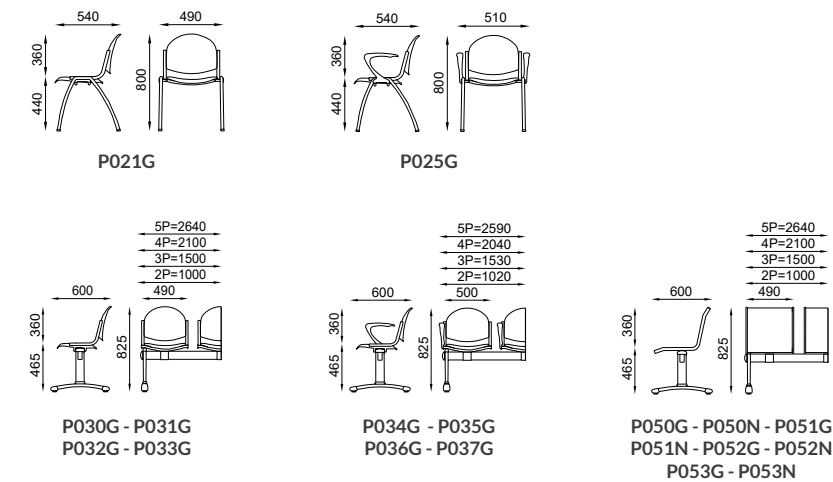

DETTAGLI / DETAILS



Carrello portasedie
Chair trolley



Gancio di allineamento sedute senza braccioli
Pair of chair union fasteners without armrests



Seduta panca tipo 1 in grigio lucido
Satin grey bench type 1



Seduta panca tipo 2 verniciato grigio goffrato
Embossed grey bench type 2



Tavolo portariviste in lamiera
Sheet metal magazine table



Bracciolo terminale per panca
Bench terminal armrest

RACE



RACE



RACE

Sedie fisse
Fixed chairs



RC01



RC03



DETTAGLI TECNICI TECHNICAL DATA

- Telaio 4 gambe di serie in acciaio cromato.
- Scocca in nylon anatomicamente sagomata nei vari colori.
- Imbottiture in resine poliuretatiche a densità differenziata schiumate a freddo e tagliate da blocco.
- Imbottiture opzionali in resine poliuretatiche a densità differenziata schiumate a freddo e tagliate da blocco, ignifughe conformi alla UNI 9175 Classe 1IM.
- Rivestimenti a scelta fra quelli delle nostre cartelle colori oppure tessuto fornito dal cliente.
- Personalizzazioni possibili di confezionare il prodotto con colori diversi a parità di categoria, usare filati a contrasto con le finiture, cucire marchio o logo nella poltrona.
- Le singole schede tecniche per articolo sono disponibili nel ns. sito www.seipo.it

- Standard four legged frame in chromed steel.
- Body in anatomically shaped nylon in various colours.
- Padding in polyurethane resin with diversified density cut from injected block.
- Optional padding in fire retardant diversified density polyurethane resin cut from injected block conform to UNI 9175 Class 1IM.
- Upholstery choices among our colour charts or supplied by the customer.
- Customization of the product in various colours from the same category, yarns of various colours in contrast to the colour of the chair, sewn logo, brand implementation or other workmanship.
- Each technical data sheet per item code is available on our website [HYPERLINK www.seipo.it](http://www.seipo.it)

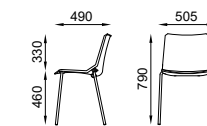

RC01-RC03

COLORI/ COLORS

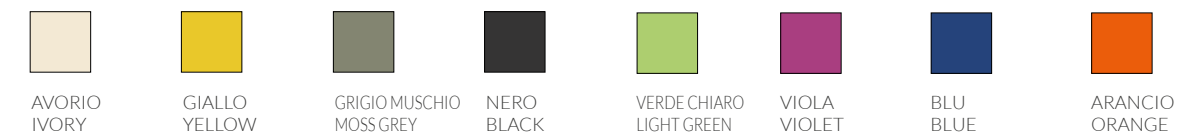

DETTAGLI / DETAILS



Sovrapponibilità
Stacked chairs



Pannellino sedile imbottito
Padded upholstered seat panel



Monoscocca con fori
Nylon monoblock design opening

LOOK



LOOK



LOOK

Sedie polipropilene
Polypropylene chairs



LP136C



LP136G



LP136N



LP137N



LP138N



LP139N

Panche polipropilene
Polypropylene benches



LP145G



LP144N



LP148N



LP152N



LP145N



LP149N



LP153N



LP146N



LP150N



LP154N



LP147N



LP151N



LP155N

LOOK

Sedie in faggio
Wood chairs



LF136C



LF136G



LF136N



LF137N



LF138N



LF139N

Panche in faggio
Wood benches



LF145G



LF144N



LF148N



LF152N



LF145N



LF149N



LF153N



LF146N



LF150N



LF154N



LF147N



LF151N



LF155N

LOOK

Sedie rivestite
Padded chairs



L136C

Panche rivestite
Padded benches



L145G



L136G



L136N



L137N



L138N



L139N



L144N



L148N



L152N



L145N



L149N



L153N



L146N



L150N



L154N



L147N



L151N



L155N

LOOK

Sedie in rete
Mesh chairs



LR136C



LR136G



LR136N



LR137N



LR138N



LR139N

Panche in rete
Mesh benches



LR145G



LR144N



LR148N



LR152N



LR145N



LR149N



LR153N



LR146N



LR150N



LR154N



LR147N



LR151N



LR155N



TENDER



TENDER

Poltrone e divani
Armchairs and sofa



TN03



TN01



TN02



TN03



 **HAND**



HAND



HAND

Poltrone e divani
Armchairs and sofa



H015



H011



H012



H013



H014



H015

DETTAGLI TECNICI TECHNICAL DATA

- Piedini in acciaio cromato autolivellanti
- Struttura in multistrato di legno
- Imbottiture in resine poliuretatiche a densità differenziate schiumate a freddo e tagliate da blocco.
- Rivestimenti a scelta fra quelli delle nostre cartelle colori oppure tessuto fornito dal cliente
- Personalizzazioni possibilità di confezionare il prodotto con colori diversi a parità di categoria, usare filati a contrasto con le finiture, cucire marchio o logo nella poltrona
- Le opzioni inerenti a gli articoli sono disponibili nel listino.
- Le singole schede tecniche per articolo sono disponibili nel ns. sito www.seipo.it

- Feet in self-levelling chromed steel.
- Structure in multilayered wood
- Padding in polyurethane resin with diversified density cut from injected block
- Upholstery choices among our colour charts or supplied by the customer
- Customization of the product in various colours from the same category, yarns of various colours in contrast to the colour of the chair, sewn logo, brand implementation or other workmanship.
- The options relating to the articles are available in the price list.
- The singular data sheets for each item are available on our website www.seipo.it

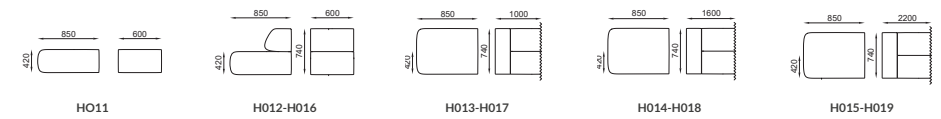

DETTAGLI / DETAILS



Cuciture sedile, schienale e braccioli
Seat, backrest and armrest seams

 **SWING**



SWING

Versione piedi in alluminio
Aluminium feet version



SW83

SWCP



SW81



SW82



SW83



 **FOSTER**

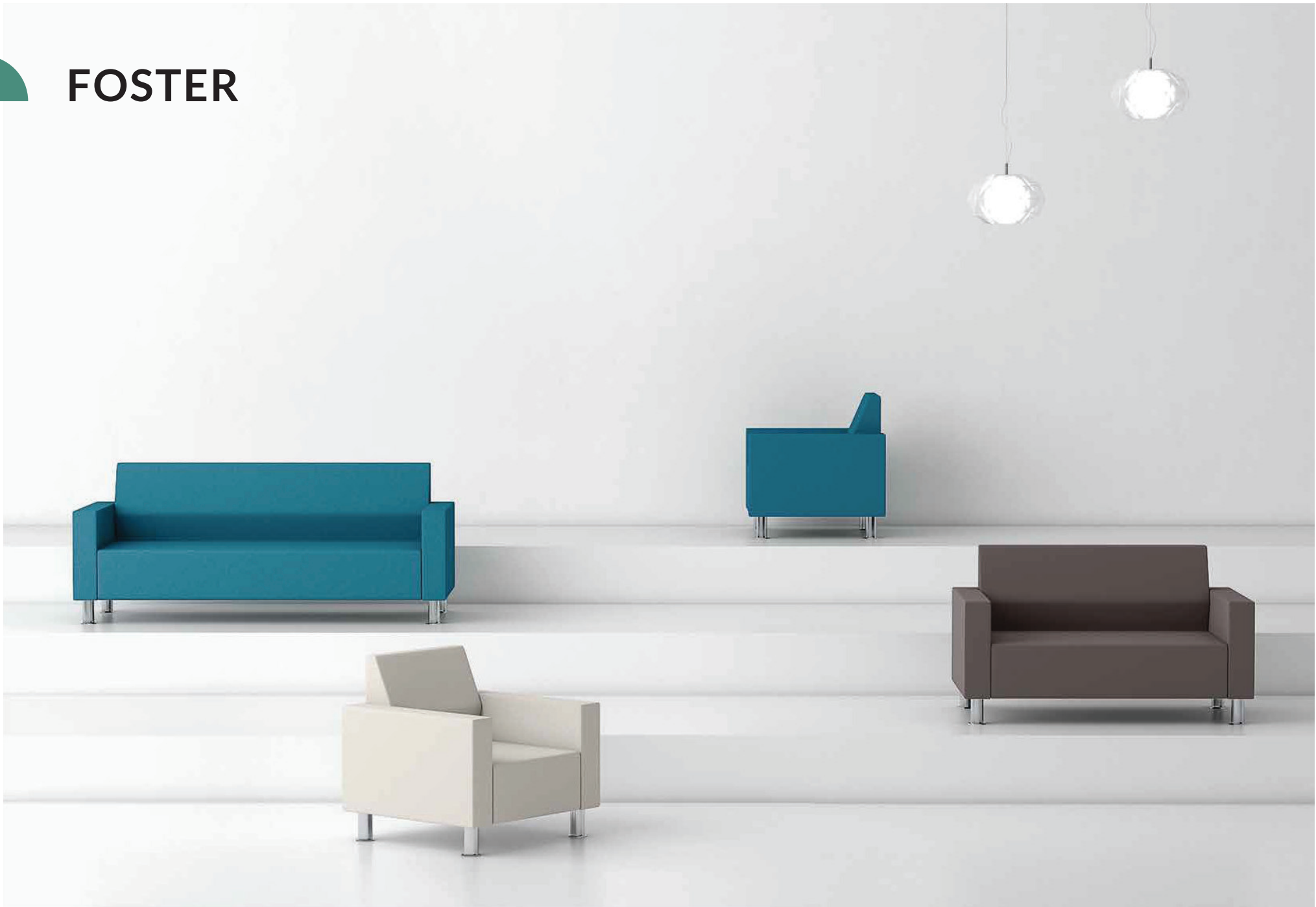

FOSTER



 **TEA**



TEA



AGREE



AGREE



 **RESET**



RESET



TETRIS



CORNER

Versione "K"
"K" version



CR38



CR31



CR36



CR32



CR33



CR34



CR35



CR37



CR39



CORNER

Versione "T"
"T" version



CR28



CR21



CR27



CR22



CR23



CR24



CR25



CR29



 TREND



TREND



TOP88[®]

SOLUZIONI INTEGRATE PER UFFICIO